

MA-FCA ADJUSTABLE FLOW CONTROL VALVE, PRESSURE COMPENSATED

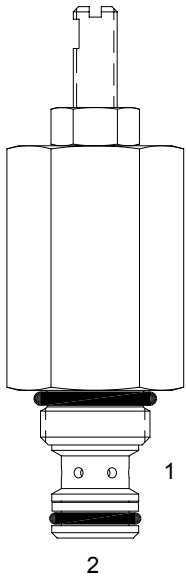

DESCRIPTION

7 size, 5/8-18 thread, "Mini" series, pressure compensated, flow control valve.

OPERATION

The cartridge maintains a constant flow rate out of (1) regardless of load pressure changes in the circuit downstream of (1). The adjustable control differential spring load can be set to customer flow specification (see options for ranges). The valve begins to respond to load changes when the flow through the valve creates a pressure differential from (2) to (1) greater than 200 PSI with accurate flow maintenance from 200 to 3000 PSI (14 to 207 bar). Reverse flow (1) to (2) returns through the control orifice and is non-compensated. The regulated flow increases from low to high with clockwise rotation of the knob.

FEATURES

- Hardened parts for long life.
- Industry common cavity.
- Fine low-torque adjustment.



Best stability is obtained with adjustment at highest flow.

HYDRAULIC SYMBOL

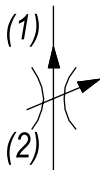

PERFORMANCE

Actual Test Data (Cartridge Only)

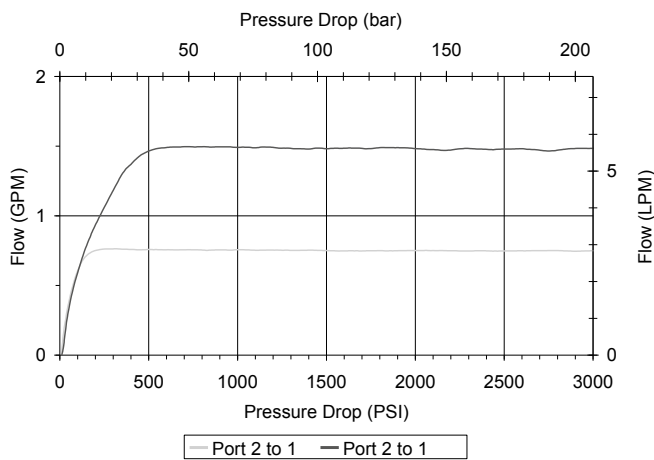

VALVE SPECIFICATIONS

Nominal Flow	3 GPM (11 LPM)
Rated Operating Pressure	3000 PSI (207 bar)
Viscosity Range	36 to 3000 SSU (3 to 647 cSt)
Filtration	ISO 18/16/13
Media Operating Temp. Range	-40° to 250°F (-40° to 120°C)
Weight	.29 lbs (.13 kg)
Operating Fluid Media	General Purpose Hydraulic Fluid
Cartridge Torque Requirements	15 ft-lbs (20.3 Nm)
Cavity	MINI 2W
Cavity Form Tool (Finishing)	40500003
Seal Kit	21191000

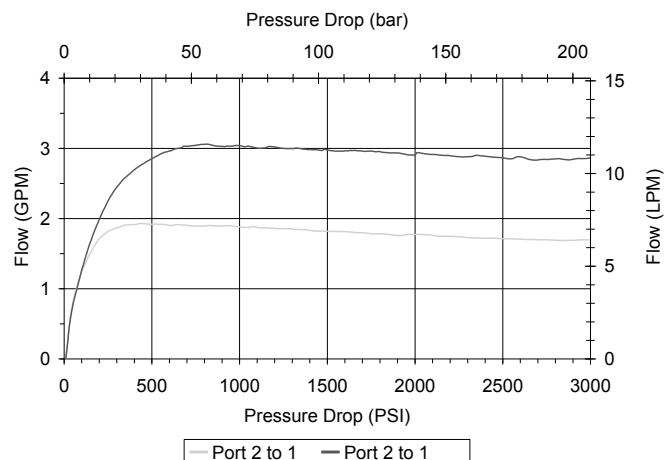

WARNING: the specifications/application data shown in our catalogs and data sheets are intended only as a general guide for the product described (herein). Any specific application should not be undertaken without independent study, evaluation, and testing for suitability.



4484 Boeing Drive Rockford, IL 61109 • USA • Phone +1 (815) 397-6628 • Fax +1 (815) 397-2526
 mail: delta@delta-power.com • www.delta-power.com



Via Malavolti, 36 • 41122 Modena • ITALY • Phone +39 (059) 254895 • Fax +39 (059) 253512
 mail: tecnord@tecnord.com • www.tecnord.com

DIMENSIONS

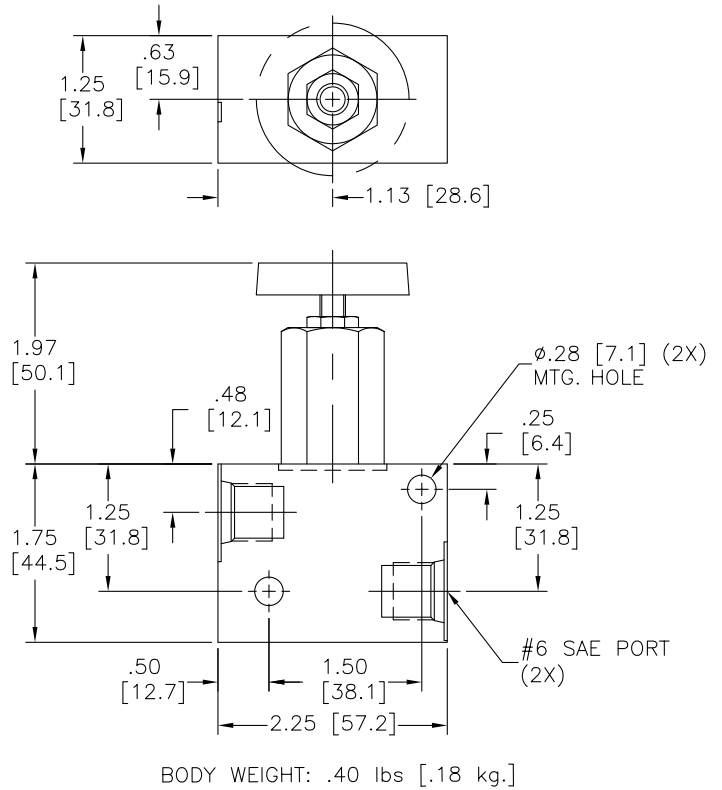
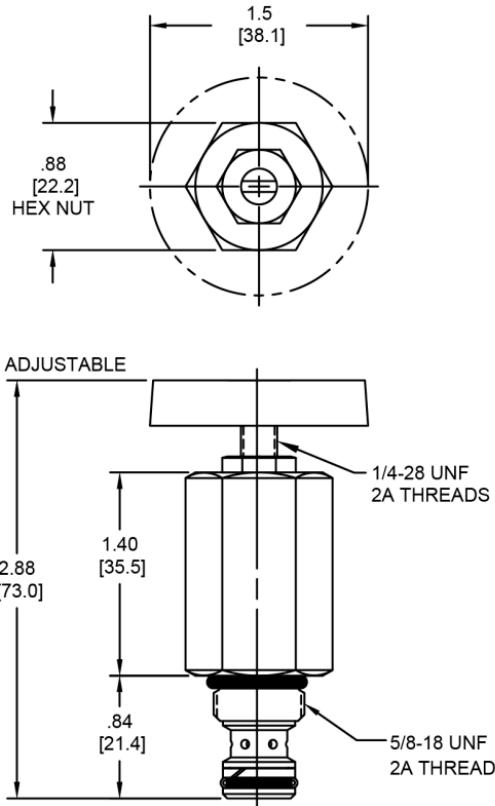

Body Weight: .29 lbs (.13 kg)

ORDERING INFORMATION

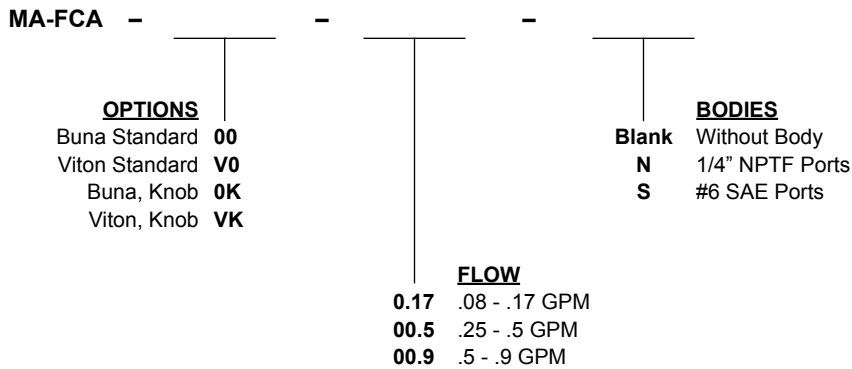

W 40 / 2017

WARNING: the specifications/application data shown in our catalogs and data sheets are intended only as a general guide for the product described (herein). Any specific application should not be undertaken without independent study, evaluation, and testing for suitability.



4484 Boeing Drive Rockford, IL 61109 • USA • Phone +1 (815) 397-6628 • Fax +1 (815) 397-2526
 mail: delta@delta-power.com • www.delta-power.com



Via Malavolti, 36 • 41122 Modena • ITALY • Phone +39 (059) 254895 • Fax +39 (059) 253512
 mail: tecnord@tecnord.com • www.tecnord.com